

MAXIM

MAX3748 Evaluation Kit

General Description

The MAX3748 evaluation kit (EV kit) simplifies evaluation of the MAX3748 limiting amplifier. The EV kit allows for quick threshold level selections, provides a RSSI output signal (when used with the MAX3744) and includes a calibration circuit. The MAX3748 EV kit is fully assembled and tested.

Component List

DESIGNATION	Q	DESCRIPTION
C1, C2, C7, C10	4	0.001 μ F 10% 10V min ceramic capacitor (0201)
C3, C4, C6, C8, C9, C11, C12 C14-C18	1 2	0.1 μ F, 10% 10V min ceramic capacitor (0402)
C20	1	2.2 μ F, 10%, 10V min ceramic capacitor (0805)
C21	1	33 μ F 10V min 5% tantalum
R3		82 Ω , 5% resistor (0201)
R4	1	270 Ω , 5% resistor (0201)
R5	1	20k Ω , 1% resistor (0401)
R6	1	4.75k Ω , 1% resistor (0402)
R7	1	10k Ω , 1% resistor (0402)
R8	1	3.01k Ω , 1% resistor (0402)
L1	1	1.2 μ H, 5% Chip inductor
JU2-JU5, JU9, JU11	6	Jumper blocks, 2 Pins 0.1" spacing
JU6, JU7, JU8	3	Jumper blocks, 3 Pins 0.1"
TP2, TP3, TP9, TP10	4	Test point Digikey 5000K-ND
JU2-JU9, JU11	9	Shunts
J1-J8	8	SMA edge mount tab Johnson 142-0701-851
U1		MAX3748EGE
	1	MAX3748 Rev A Evaluation Circuit Board
	1	MAX3748 Data Sheet

Features

- ◆ Fully Assembled and Tested
- ◆ Test Point for Easy Monitoring of LOS
- ◆ Polarity Reversal Control
- ◆ Selectable Offset Correction Loop Capacitance
- ◆ Jumpers Allow Quick Selection for Loss of Signal Threshold Level

Ordering Information

PART	TEMP. RANGE	IC PACKAGE
MAX3748EVKIT	-40°C to +85°C	16 QFN

Component Suppliers

SUPPLIER	PHONE	FAX
AVX	843-444-2863	843-626-3123
Coilcraft	847-639-6400	847-639-1469
Murata	415-964-6321	415-964-8165

Note: Please indicate that you are using the MAX3748 when ordering from these suppliers.

Evaluates: MAX3748

MAX3748 Evaluation Kit

Evaluates: MAX3748

Quick Start

- 1) Connect OUT+ and OUT- to a 50Ω terminated oscilloscope.
- 2) Connect IN+ and IN- to a 500mV_{p-p}, 3.2Gbps differential data stream.
- 3) Remove all shunts.
- 4) Shunt JU8 to V_{CC} so that there is no inversion of signal polarity. (OUTPOL, V_{CC}). Figure 2 shows the jumper diagram for the board.
- 5) Shunt JU4 connecting R3 = 82 Ω (R_{TH}).
- 6) Shunt JU6 connecting R7 = 10k Ω (R_{LOS}).
- 7) Shunt JU5 connecting pin LOS to DISABLE.
- 8) Connect TP2 to V_{CC}.
- 9) Shunt jumper JU11 so that the capacitor C12 is connected to pins CAZ1 and CAZ2.
- 10) Connect the power-supply ground to the GND pad and then connect a +3.3V power supply to the V_{CC}.
- 11) Observe a limited signal at the output, roughly 0.8V_{p-p}.
- 12) Lower the amplitude of the input signal from 500mV_{p-p} to 15mV_{p-p} or less. The output signal is squelched.

Adjustment and Control Descriptions (see Quick Start first)

NAME	FUNCTION
JU2, JU3, JU4	Selects loss of signal assert/deassert level.
JU5	Shunt to connect the LOS pin to the DISABLE pin (Squelch)
JU6	Shunt to connect series resistor from LOS to test point TP2. Make sure TP2 is connected to a positive supply.
JU7	Disable. Shunting to V _{CC} holds the outputs static.
JU8	Shunt to GND to reverse the output signal's polarity (OUTPOL). For normal operation, shunt to V _{CC} .
JU9	Shunt to connect RSSI output to RSSI resistor R8.
JU11	Shunt to connect C12 to CAZ1 and CAZ2

MAX3748 Evaluation Kit

Evaluates: MAX3748

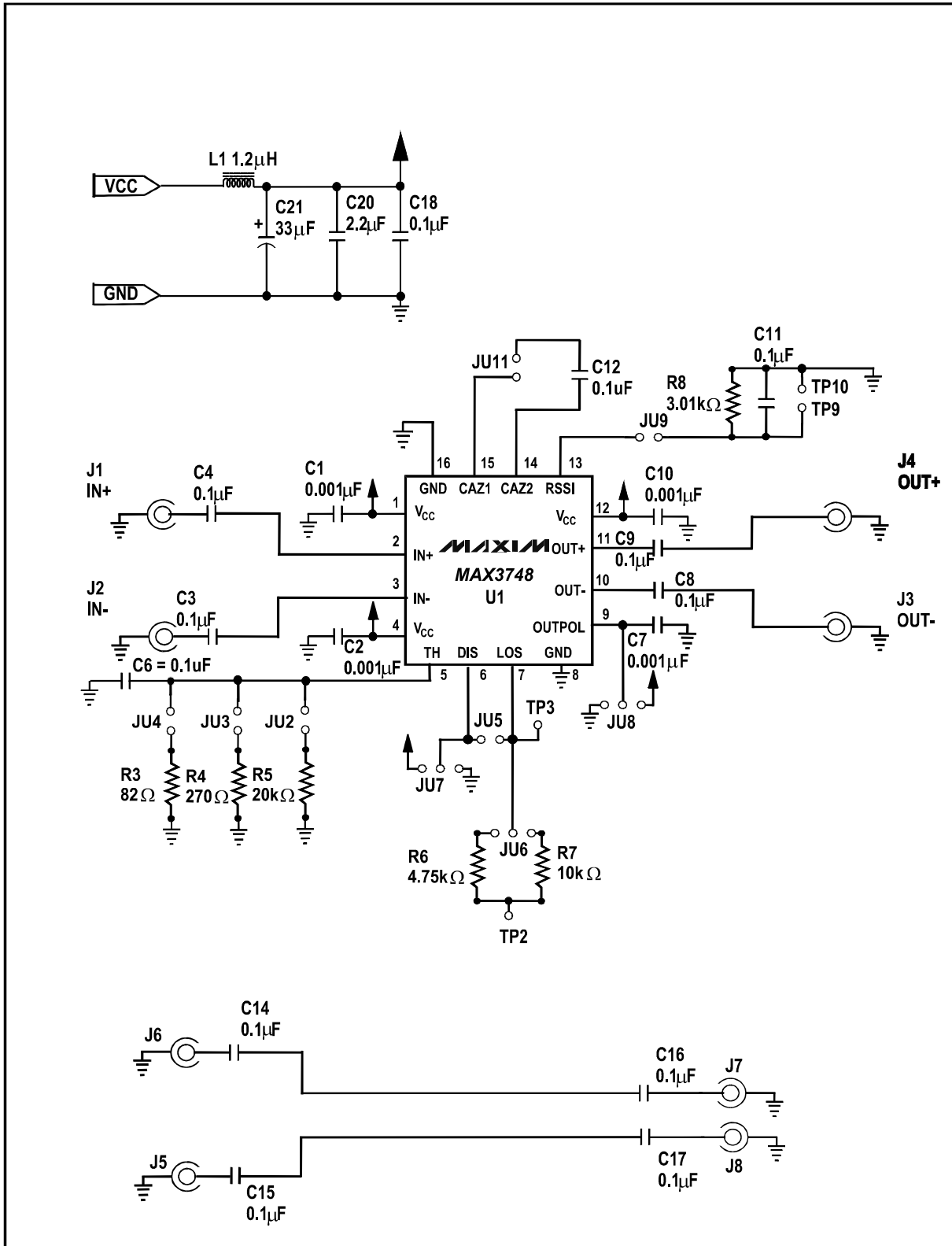

Figure 1 MAX3748 EV Kit Schematic.

MAX3748 Evaluation Kit

Evaluates: MAX3748

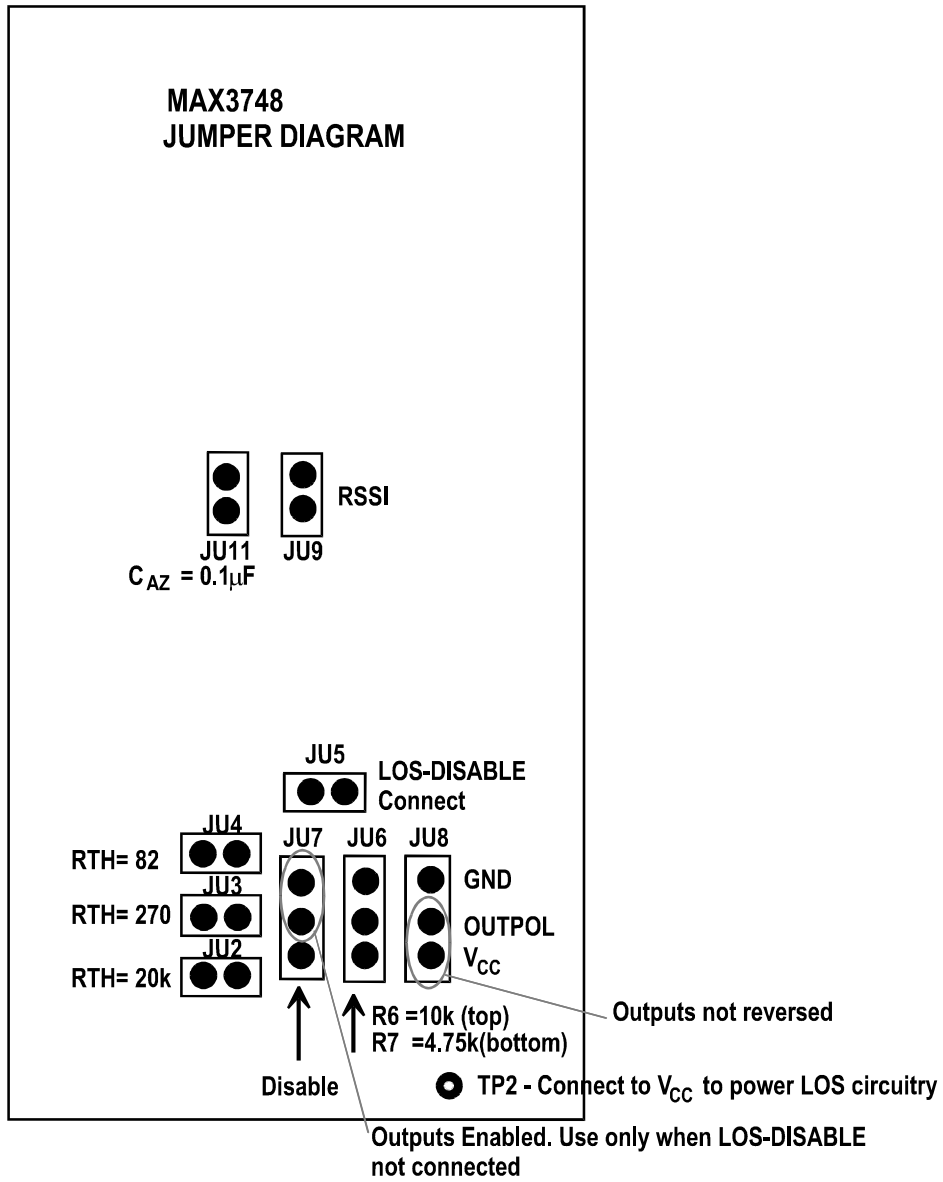

Figure 2. Jumper Diagram.

MAX3748 Evaluation Kit

Evaluates: MAX3748

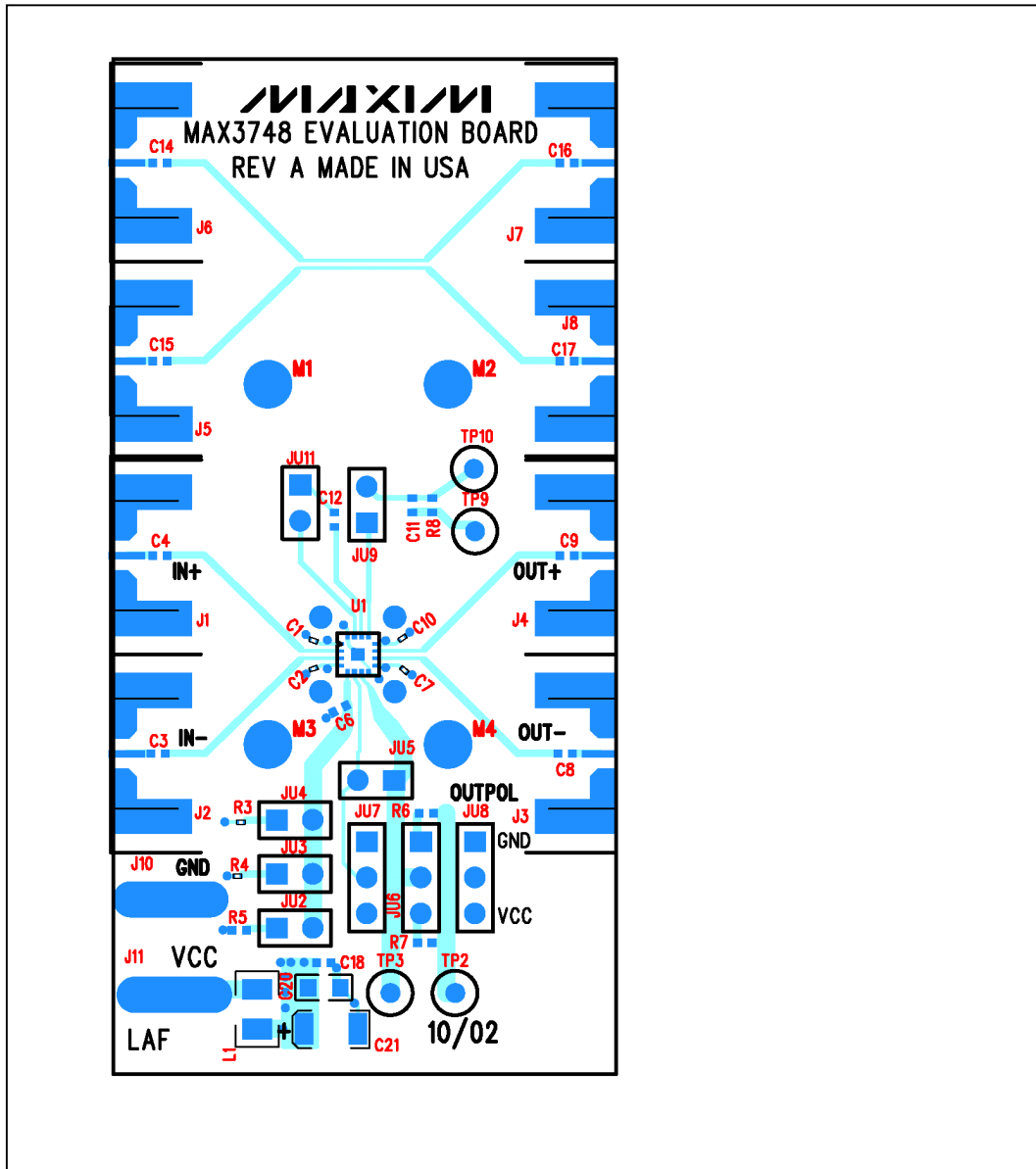

Figure 3. MAX3748 EV Kit Component Placement Guide – Component Side (2X)

MAX3748 Evaluation Kit

Evaluates: MAX3748

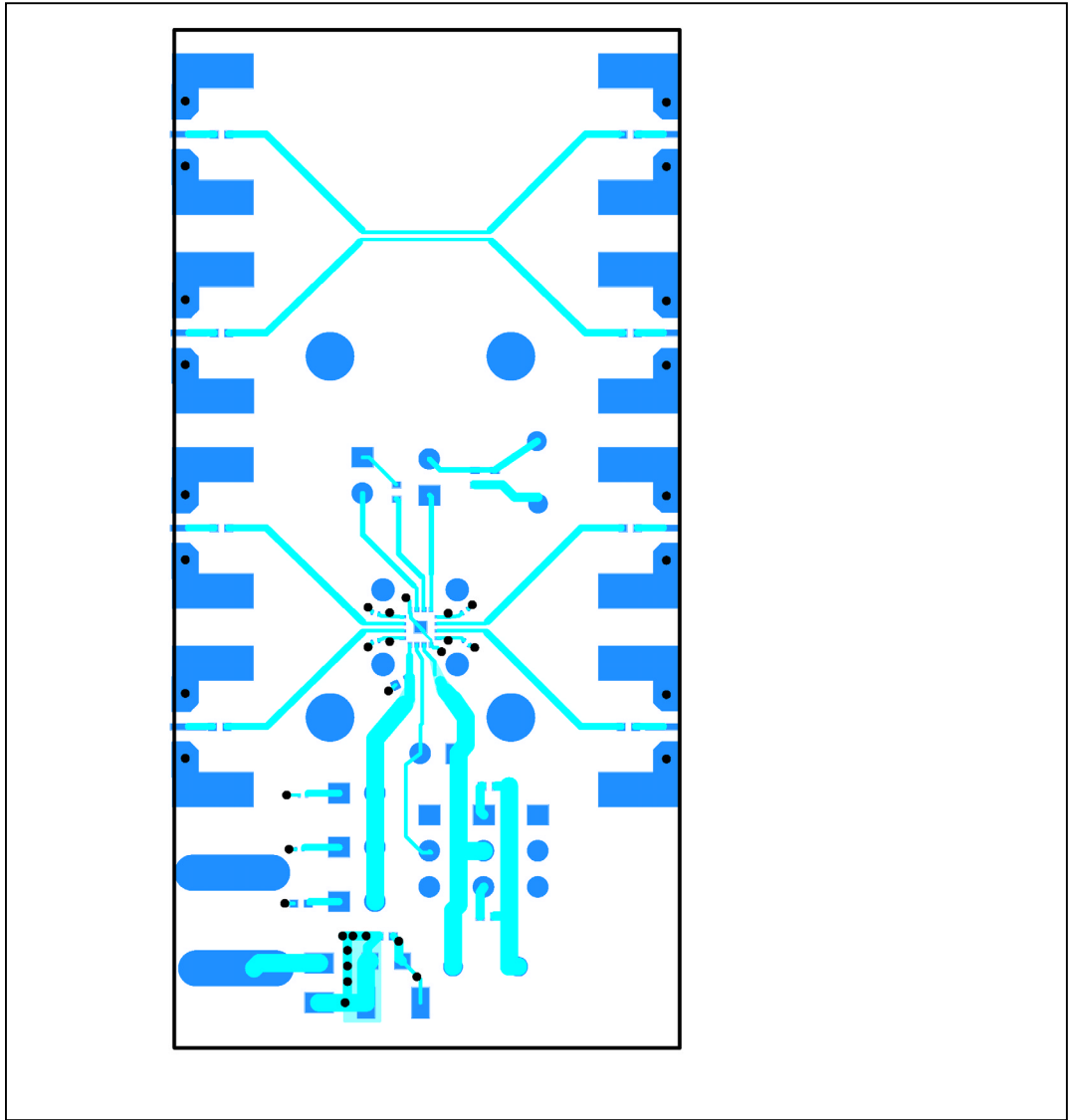

Figure 4. MAX3748 EV Kit PC Board Layout – Component Side (2X)

MAX3748 Evaluation Kit

Evaluates: MAX3748

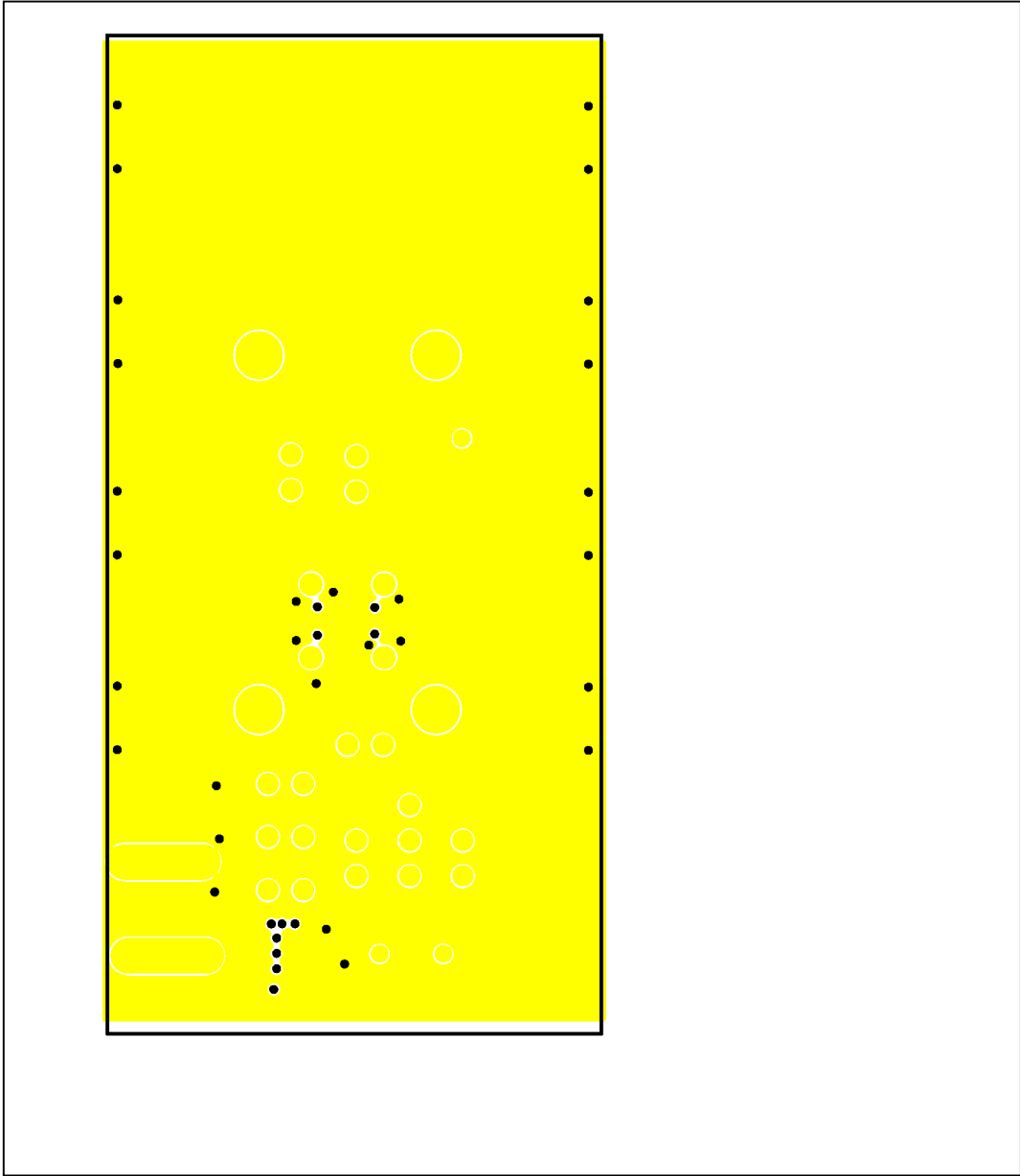

Figure 5. MAX3748 EV Kit PC Board Layout – Ground Plane (2X)

MAX3748 Evaluation Kit

Evaluates: MAX3748

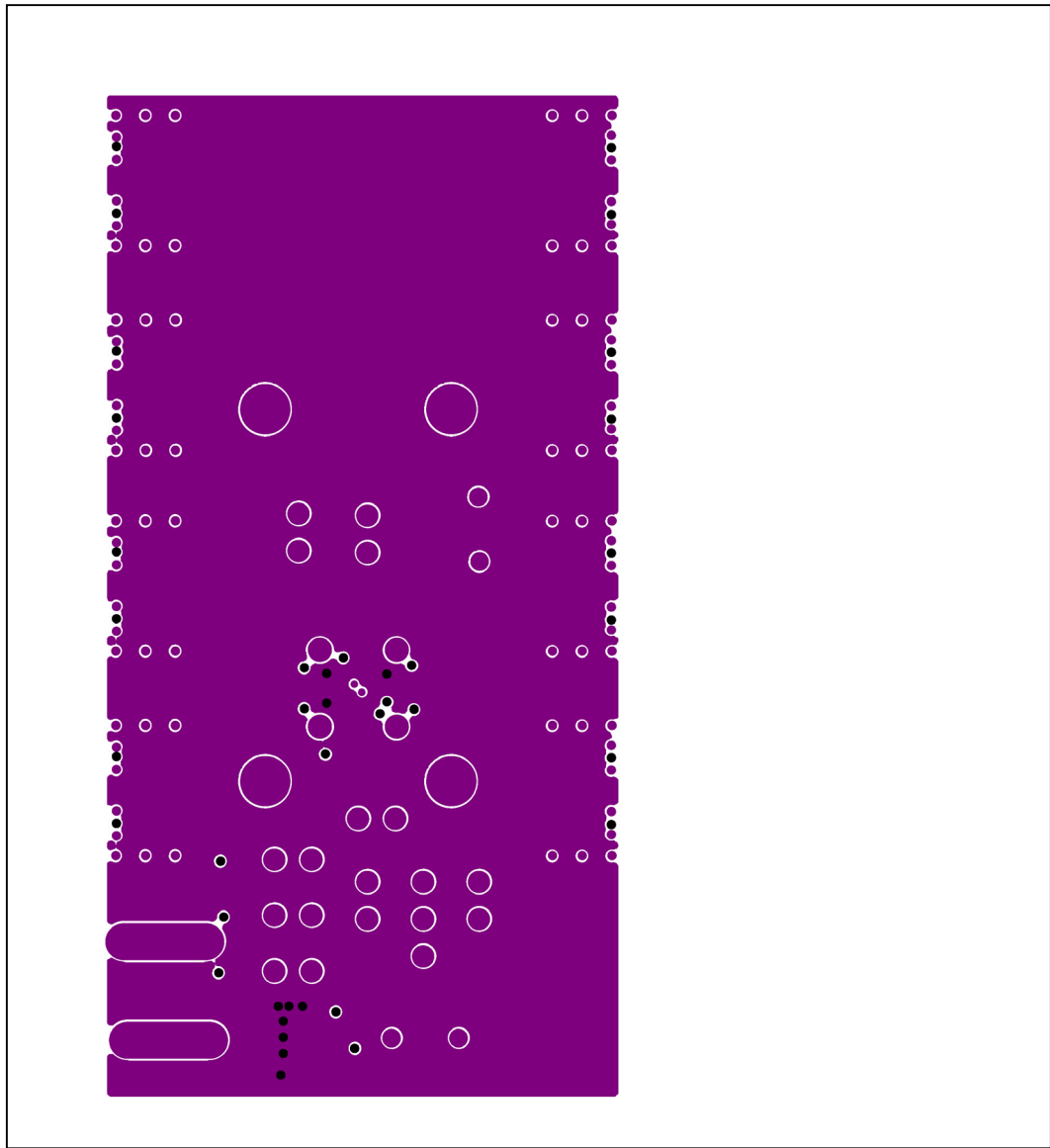

Figure 6. MAX3748 EV Kit PC Board Layout – Power Plane (2X)

MAX3748 Evaluation Kit

Evaluates: MAX3748

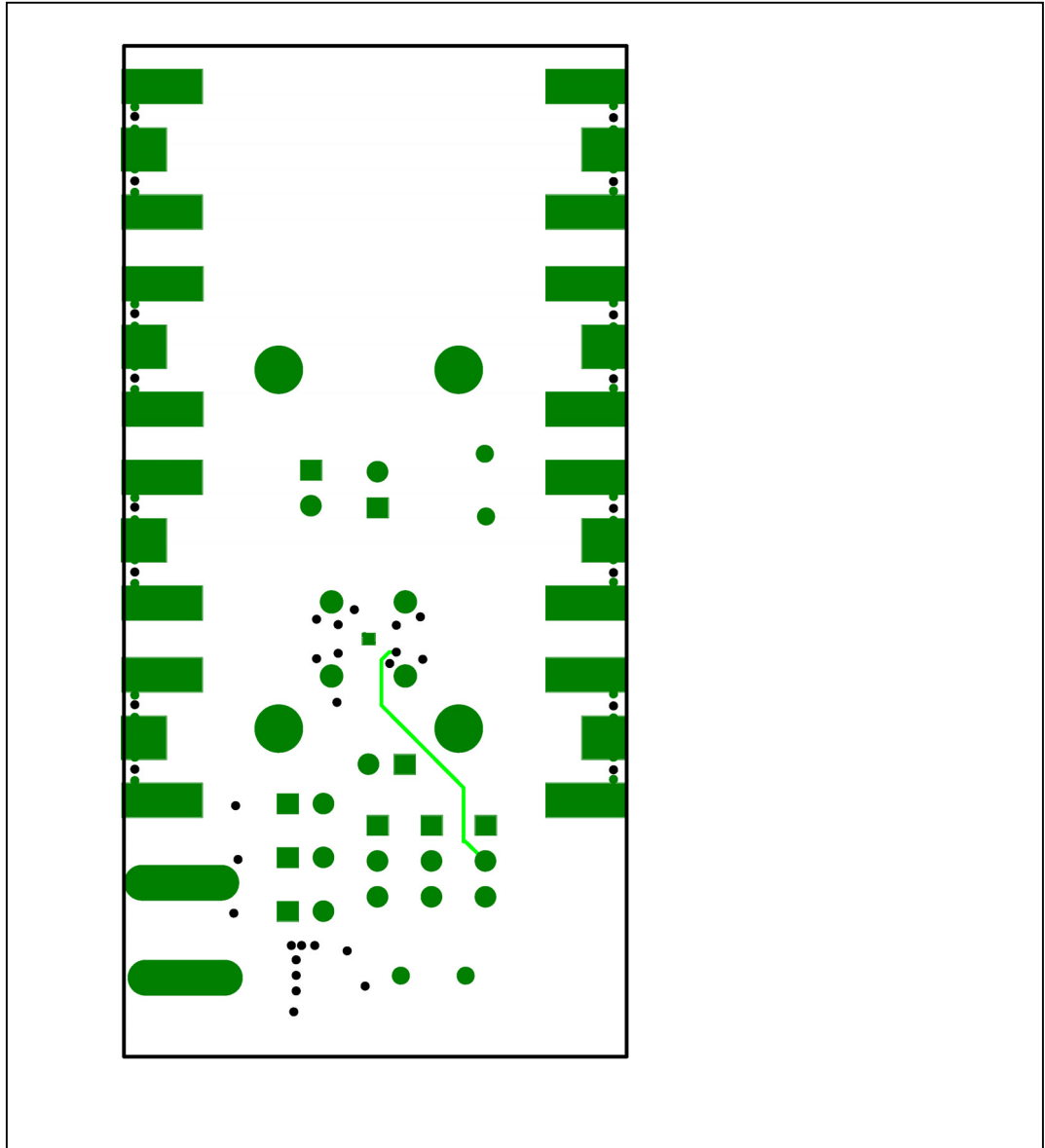

Figure 7. MAX3748 EV Kit PC Board Layout – Solder Side (2X)

Maxim makes no warranty, representation or guarantee regarding the suitability of its products for any particular purpose, nor does Maxim assume any liability arising out of the application or use of any product or circuit and specifically disclaims any and all liability, including without limitation consequential or incidental damages. “Typical” parameters can and do vary in different applications. All operation parameters, including “typicals” must be validated for each customer application by customer’s technical experts. Maxim products are not designed, intended or authorized for use as components in systems intended for surgical implant into the body, or other applications intended to support or sustain life, or for any other application in which the failure of the Maxim product could create a situation where personal injury or death may occur.

Maxim cannot assume responsibility for use of any circuitry other than circuitry entirely embodied in a Maxim product. No circuit patent licenses are implied. Maxim reserves the right to change the circuitry and specifications without notice at any time.

Maxim Integrated Products, 120 San Gabriel Drive, Sunnyvale, CA 94086 408-737-7600 _____ 9